



rtc

COUPLING TECHNOLOGY

www.rtc-tec.com



098

rtc TYPE



Temperature Range - Temperaturbereich
FPM (V) -20°C + 180°C (- 4°F + 356°F)

Working Pressure - Betriebsdruck
rtc 098.06 16 bar (290 PSI)
rtc 098.08 20 bar (290 PSI)
rtc 098.12 20 bar (290 PSI)

Working Pressure - Betriebsdruck
Stainless Steel - Edelstahl
rtc 098.08 100 bar (1450 PSI)
rtc 098.12 100 bar (1450 PSI)

Flow size - Nennweite
rtc 098.06 6 mm
rtc 098.08 8 mm
rtc 098.12 12 mm

Material of Standard Coupler
Material für die Standardversion
Socket body - Brass -
Kupplungsgrundkörper Messing
Valve - Ventil Brass - Messing
Springs - Federn Stainless Steel - Edelstahl

Plug body - Brass Nickel plated -
Nippelsgrundkörper Messing vernickelt
Plug back part Brass
Nippel hinterteil Messing

Material of rtc 098.06
- Aluminium socket and plug body
- Aluminium Nippel und Kupplungsgrundkörper

Using Area

- On temperature regulation applications of mold and tool changer with hot or cold water, oil etc
- Injection moulding industries
- On steam line

Anwendungsbereiche

- Werkzeugtemperierung
- Kühlung mit Öl oder Wasser
- Kunststoffindustrie
- Dampfanwendungen

Material of Stainless Steel Coupler
Material für die Edelstahlversion
Socket body - Stainless Steel -
Kupplungsgrundkörper Edelstahl
Sleeve - Stainless Steel -
Hülse Stahl vernickelt
Springs - Federn Stainless Steel - Edelstahl
Locking Ring - Sprengring Stainless Steel - Edelstahl
Balls - Kugeln Stainless Steel - Edelstahl
Plug - Nippel Stainless Steel - Edelstahl



Flow Rate vs Pressure Drop Graph / Durchflussrate vs Druckabfall

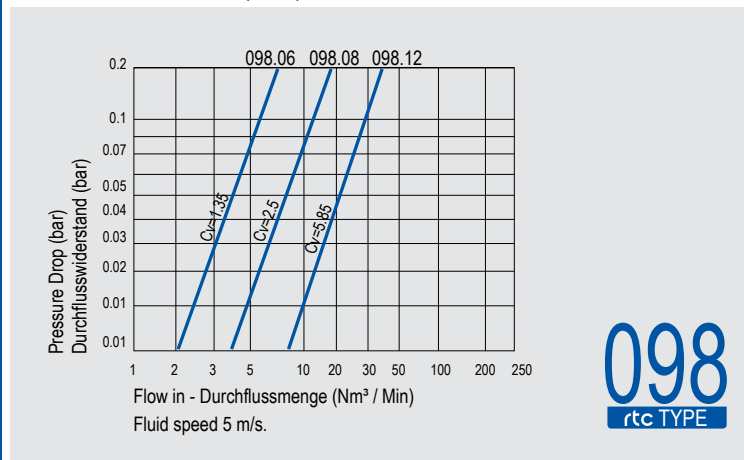

098
rtc TYPE

rtc TYPE 098.06

Male thread socket with valve / Verschlusskupplung mit Aussengewinde



Socket / Kupplung

Size / Grosse	Order No / Bestellnr.	Ød	Ød1	L	L1	HEX.
6.0	098.06 SMB 1810	M18x1.0	22	18.2	7.2	20
6.0	098.06 SMB 1810-DH	M18x1.0	22	18.2	7.2	20

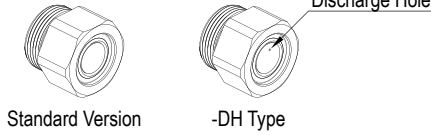
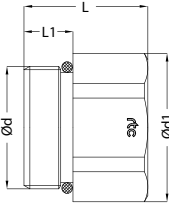

rtc TYPE 098.06

Male thread plug with valve / Verschlussnippel mit Aussengewinde



Plugs / Nippel

Size / Grosse	Order No / Bestellnr.	Ød	Ød1	L	L1	L2	L3	HEX.
6.0	098.06 PMB 1810	M18x1.0	22	31.8	10.5	5.9	20.5	20

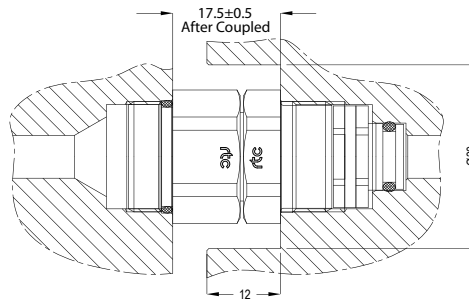
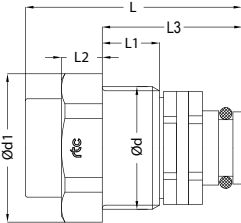

rtc TYPE 098

Male thread socket with valve / Verschlusskupplung mit Aussengewinde

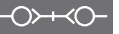

Socket / Kupplung

Size / Grosse	Order No / Bestellnr.	Ød	Ød1	Ød2	L	L1	HEX.
8.0	098.08 SMB 2415	M24x1.5	27	29.5	22	6.5	27
12.0	098.12 SMB 3315	M33x1.5	38	42	22	6.5	38

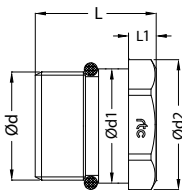

rtc TYPE 098

Female thread socket with valve / Verschlusskupplung mit Innengewinde



Socket / Kupplung

Size / Grosse	Order No / Bestellnr.	Ød	Ød1	Ød2	L	L1	HEX.
8.0	098.08 SFB 17	BSP 3/8	27	29.5	40.5	6.5	27
12.0	098.12 SFB 26	BSP 3/4	38	42	48	6.5	38

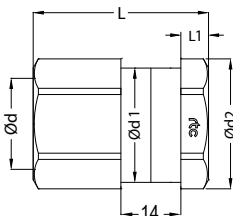



Male thread plug with valve / Verschlussnippel mit Aussengewinde

TYPE 098



Plugs / Nippel

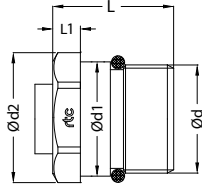

Size / Grosse	Order No / Bestellnr.	Ød	Ød1	Ød2	L	L1	HEX.
8.0	098.08 PMB 2415	M24x1.5	27	29.5	22	6.5	27
12.0	098.12 PMB 3315	M33x1.5	38	42	22	6.5	38



Female thread plug with valve / Verschlussnippel mit Innengewinde

TYPE 098



Plugs / Nippel

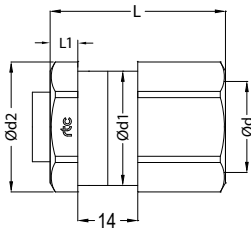

Size / Grosse	Order No / Bestellnr.	Ød	Ød1	Ød2	L	L1	HEX.
8.0	098.08 PFB 17	BSP 3/8	27	29.5	46	6.5	27
12.0	098.12 PFB 26	BSP 3/4	38	42	48	6.5	38



90° Female thread socket with valve / 90° Verschlusskupplung mit Innengewinde

TYPE 098



Socket / Kupplung

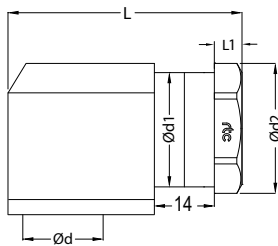

Size / Grosse	Order No / Bestellnr.	Ød	Ød1	Ød2	L	L1	HEX.
8.0	098.08 SFB 17-90	BSP 3/8	27	29.5	63	6.5	27
12.0	098.12 SFB 21-90	BSP 1/2	38	42	63	6.5	38
12.0	098.12 SFB 26-90	BSP 3/4	38	42	68	6.5	38



90° Female thread plug with valve / 90° Verschlussnippel mit Innengewinde

TYPE 098



Plugs / Nippel

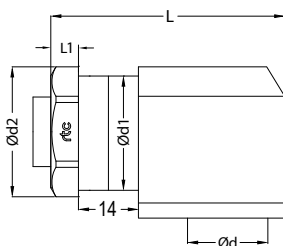

Size / Grosse	Order No / Bestellnr.	Ød	Ød1	Ød2	L	L1	HEX.
8.0	098.08 PFB 17-90	BSP 3/8	27	29.5	63	6.5	27
12.0	098.12 PFB 21-90	BSP 1/2	38	42	63	6.5	38
12.0	098.12 PFB 26-90	BSP 3/4	38	42	68	6.5	38

