



rtc[®]

COUPLING TECHNOLOGY



026

rtc TYPE



DN 7.2 mm Pneumatic Coupling

TYPE 026



Compatible - Kompatibilität

rtc 463.08
rtc 025
Rectus 25KA, 26KA
Cejn 320
Tema 1600

Temperature Range - Temperaturbereich

Nitrile (N) -20°C + 100°C (- 4°F + 212°F)
FPM (V) -20°C + 180°C (- 4°F + 356°F)
EPDM (Ethylene Propylene) -40°C + 150°C (- 40°F + 302°F)

Working Pressure - Betriebsdruck

35 Bar (510 PSI)

Flow size - Nennweite

rtc type 026 7.2 mm

Standard version - Standardversion

Seals - Dichtung : Nitrile (N)

Material of Standard Coupler

Material für die Standardversion

Socket body - Kupplungsgrundkörper	Brass - Messing
Sleeve - Hülse	Brass - Messing
Springs - Federn	Stainless Steel - Edelstahl
Locking Ring - Sprengring	Stainless Steel - Edelstahl
Balls - Kugeln	Stainless Steel - Edelstahl
Plug - Nippel	Brass - Messing

Technical Specifications & Advantages

- Standard pneumatic coupler in the industry.
- Advantage of one hand useage.
- Corrosion resistant.

Technische Daten und Vorteile

- Standard Pneumatik Kupplung für die Industrie.
- Vorteil durch Einhandbedienung.
- Korrosionsbeständig



Flow Rate vs Pressure Drop Graph

Air / Luft

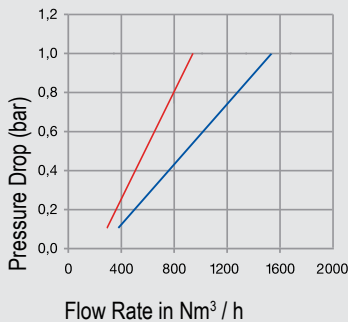

Water / Wasser

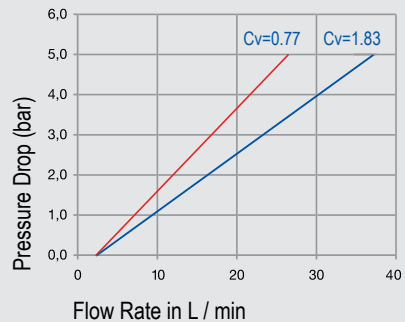

026
rtc TYPE

rtc TYPE 026 Male thread socket / Kupplung mit Aussengewinde

Sockets / Kupplungen

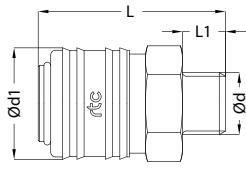

*G1/2 male threaded socket with inner G1/4 female thread Order No: 026 SMO 21-F13

Size / Größe	Order No / Bestellnr.	Order No / Bestellnr.	Order No / Bestellnr.	Ød	Ød1	L	L1	HEX.
7.2	026 SMB 10	026 SMO 10	026 SMF 10	BSP 1/8	23	39	8	21
	026 SMB 13	026 SMO 13	026 SMF 13	BSP 1/4	23	40	9	21
	026 SMB 17	026 SMO 17	026 SMF 17	BSP 3/8	23	41	9	21
	026 SMB 21	026 SMO 21	026 SMF 21	BSP 1/2	23	41	12	22
	026 SMB 21-F13*	026 SMO 21-F13*	026 SMF 21-F13*	BSP 1/2-1/4	23	38	10	21
	026 SMB 1415	026 SMO 1415	026 SMF 1415	M14x1.5	23	41	10	21
	026 SMB 1615	026 SMO 1615	026 SMF 1615	M16x1.5	23	41	10	21
	026 SMB 1815	026 SMO 1815	026 SMF 1815	M18x1.5	23	41	10	21

rtc TYPE 026 Female thread socket / Kupplung mit Innengewinde

Sockets / Kupplungen

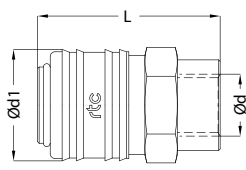

Size / Größe	Order No / Bestellnr.	Order No / Bestellnr.	Order No / Bestellnr.	Ød	Ød1	L	HEX.
7.2	026 SFB 10	026 SFO 10	026 SFF 10	BSP 1/8	23	37	21
	026 SFB 13	026 SFO 13	026 SFF 13	BSP 1/4	23	39	21
	026 SFB 17	026 SFO 17	026 SFF 17	BSP 3/8	23	39	21
	026 SFB 21	026 SFO 21	026 SFF 21	BSP 1/2	23	42	24
	026 SFB 1415	026 SFO 1415	026 SFF 1415	M14x1.5	23	40	21
	026 SFB 1615	026 SFO 1615	026 SFF 1615	M16x1.5	23	40	21
	026 SFB 1815	026 SFO 1815	026 SFF 1815	M18x1.5	23	40	22

rtc TYPE 026 Standard hose tail socket / Kupplung mit gerader Standard - Schlauchtülle

Sockets / Kupplungen

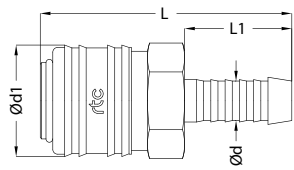

Size / Größe	Order No / Bestellnr.	Order No / Bestellnr.	Order No / Bestellnr.	Ød	Ød1	L	L1
7.2	026 SHB 06	026 SHO 06	026 SHF 06	6 mm	23	56	23
	026 SHB 08	026 SHO 08	026 SHF 08	8 mm	23	56	23
	026 SHB 09	026 SHO 09	026 SHF 09	9 mm	23	56	23
	026 SHB 10	026 SHO 10	026 SHF 10	10 mm	23	56	23
	026 SHB 13	026 SHO 13	026 SHF 13	13 mm	23	56	23

rtc TYPE 026 Socket with plastic hose connection / Kupplung mit Kunststoffschlauch

Sockets / Kupplungen

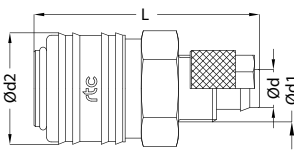

Size / Größe	Order No / Bestellnr.	Order No / Bestellnr.	Order No / Bestellnr.	Ød	Ød1	Ød2	L
7.2	026 SVB 0406	026 SVO 0406	026 SVF 0406	4x6 mm	M10x1	23	44
	026 SVB 0608	026 SVO 0608	026 SVF 0608	6x8 mm	M12x1	23	44
	026 SVB 0810	026 SVO 0810	026 SVF 0810	8x10 mm	M14x1	23	48
	026 SVB 0912	026 SVO 0912	026 SVF 0912	9x12 mm	M16x1	23	48

rtc TYPE 026 Plastic Hose Connection With Spring Guard / Knickschutzfeder

Sockets / Kupplungen

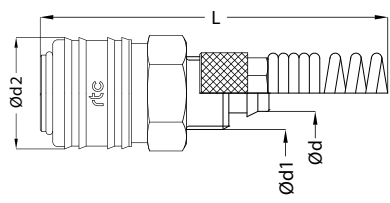

Size / Größe	Order No / Bestellnr.	Order No / Bestellnr.	Order No / Bestellnr.	Ød	Ød1	Ød2	L
7.2	026 SVBG 0608	026 SVOG 0608	026 SVFG 0608	6x8 mm	M10x1	23	132
	026 SVBG 0810	026 SVOG 0810	026 SVFG 0810	8x10 mm	M12x1	23	142
	026 SVBG 0912	026 SVOG 0912	026 SVFG 0912	9x12 mm	M16x1	23	152

rtc TYPE 026 Panel Mount Hose Barb / Schottverschraubung für Schlauchanschluss

Sockets / Kupplungen

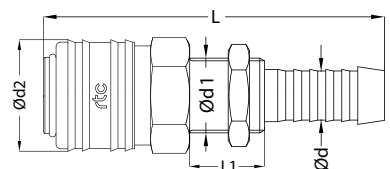

Size / Größe	Order No / Bestellnr.	Order No / Bestellnr.	Order No / Bestellnr.	Ød	Ød1	Ød2	L	L1	HEX.
7.2	026 SHBP 0610	026 SHOP 0610	026 SHFP 0610	6	M12x1	23	61	10	21
	026 SHBP 0812	026 SHOP 0812	026 SHFP 0812	8	M12x1	23	61	14	21
	026 SHBP 1012	026 SHOP 1012	026 SHFP 1012	10	BSP 1/4	23	67	14	21



Y Distributor / Y Verteiler

TYPE 026

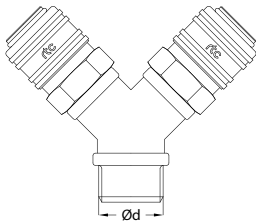

Body Size Größe	Order No Bestellnr.	Ød
7.2	026 SMOY 17	BSP 3/8
7.2	026 SMOY 21	BSP 1/2

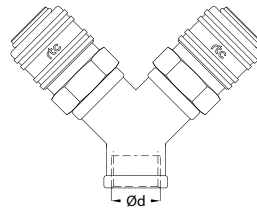

Body Size Größe	Order No Bestellnr.	Ød
7.2	026 SFOY 17	BSP 3/8
7.2	026 SFOY 21	BSP 1/2

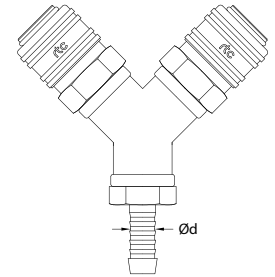

Body Size Größe	Order No Bestellnr.	Ød
7.2	026 SHOY 10	Ø 10
7.2	026 SHOY 13	Ø 13



W Distributor / W Verteiler

TYPE 026

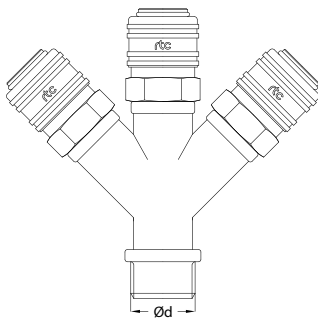

Body Size Größe	Order No Bestellnr.	Ød
7.2	026 SMOW 17	BSP 3/8
7.2	026 SMOW 21	BSP 1/2

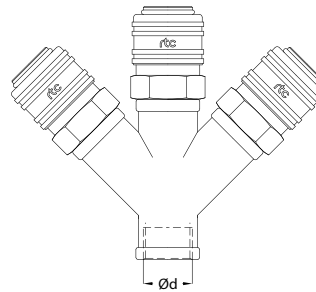

Body Size Größe	Order No Bestellnr.	Ød
7.2	026 SFOW 17	BSP 3/8
7.2	026 SFOW 21	BSP 1/2

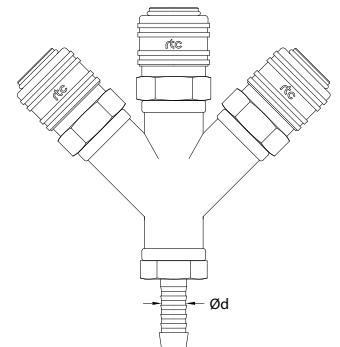

Body Size Größe	Order No Bestellnr.	Ød
7.2	026 SHOW 10	Ø 10
7.2	026 SHOW 13	Ø 13



T Distributor / T Verteiler

TYPE 026

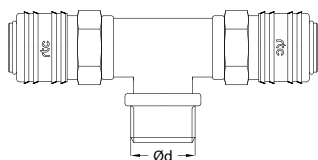

Body Size Größe	Order No Bestellnr.	Ød
7.2	026 SMOT 17	BSP 3/8
7.2	026 SMOT 21	BSP 1/2

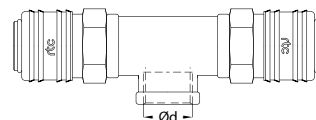

Body Size Größe	Order No Bestellnr.	Ød
7.2	026 SFOT 17	BSP 3/8
7.2	026 SFOT 21	BSP 1/2

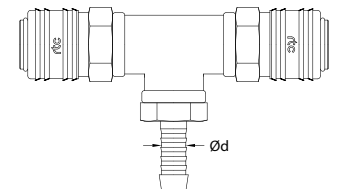

Body Size Größe	Order No Bestellnr.	Ød
7.2	026 SHOT 10	Ø 10
7.2	026 SHOT 13	Ø 13



X Distributor / X Verteiler

TYPE 026

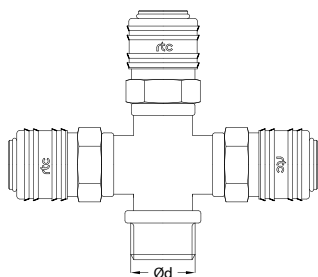

Body Size Größe	Order No Bestellnr.	Ød
7.2	026 SMOX 17	BSP 3/8
7.2	026 SMOX 21	BSP 1/2

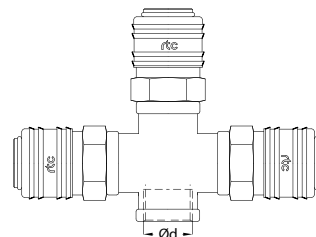

Body Size Größe	Order No Bestellnr.	Ød
7.2	026 SFOX 17	BSP 3/8
7.2	026 SFOX 21	BSP 1/2

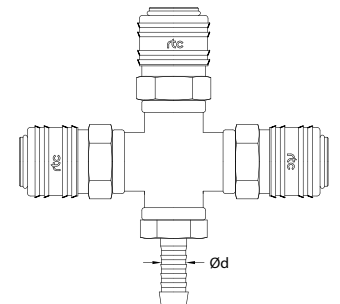

Body Size Größe	Order No Bestellnr.	Ød
7.2	026 SHOX 10	Ø 10
7.2	026 SHOX 13	Ø 13

rtc TYPE 026 Male thread plug / Nippel mit Aussengewinde

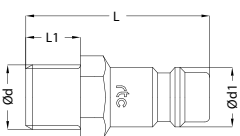
Plugs / Nippel	Size / Größe	Order No / Bestellnr.	Ød	Ød1	L	L1	HEX.
	7.8	026 PMF 10	BSP 1/8	12	32	8	14
		026 PMF 13	BSP 1/4	12	33	9	14
		026 PMF 17	BSP 3/8	12	33	9	19
		026 PMF 21	BSP 1/2	12	38	12	22
		026 PMF 1415	M14x1.5	12	35	10	17
		026 PMF 1615	M16x1.5	12	35	10	19
		026 PMF 1815	M18x1.5	12	35	10	22

rtc TYPE 026 Female thread plug / Nippel mit Innengewinde

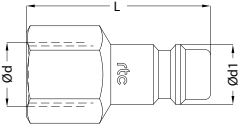
Plugs / Nippel	Size / Größe	Order No / Bestellnr.	Ød	Ød1	L	HEX.
	7.8	026 PFF 10	BSP 1/8	12	30	14
		026 PFF 13	BSP 1/4	12	33	17
		026 PFF 17	BSP 3/8	12	33	19
		026 PFF 21	BSP 1/2	12	35	24
		026 PFF 1415	M14x1.5	12	33	17
		026 PFF 1615	M16x1.5	12	33	19
		026 PFF 1815	M18x1.5	12	35	22

rtc TYPE 026 Standard hose tail plug / Nippel mit gerader Standard - Schlauchtülle

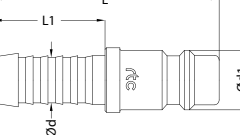
Plugs / Nippel	Size / Größe	Order No / Bestellnr.	Ød	Ød1	L	L1
	7.8	026 PHF 04	4 mm	12	46	23
		026 PHF 06	6 mm	12	46	23
		026 PHF 08	8 mm	12	46	23
		026 PHF 09	9 mm	12	46	23
		026 PHF 10	10 mm	12	46	23
		026 PHF 13	13 mm	12	46	23

rtc TYPE 026 Socket with plastic hose connection / Kupplung mit Kunststoffschlauch

Plugs / Nippel	Size / Größe	Order No / Bestellnr.	Ød	Ød1	Ød2	L
	7.8	026 PVF 0406	4x6 mm	M10x1	12	34
		026 PVF 0608	6x8 mm	M12x1	12	34
		026 PVF 0810	8x10 mm	M14x1	12	42
		026 PVF 0912	9x12 mm	M16x1	12	42

rtc TYPE 026 Plug with plastic hose connection spring guard / Nippel mit Knickschutzfeder

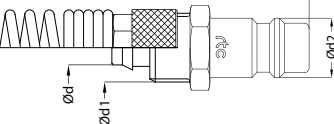
Plugs / Nippel	Size / Größe	Order No / Bestellnr.	Ød	Ød1	Ød2	L
	7.8	026 PVFG 0406	4x6 mm	M10x1	12	110
		026 PVFG 0608	6x8 mm	M12x1	12	120
		026 PVFG 0810	8x10 mm	M14x1	12	130
		026 PVFG 0912	9x12 mm	M16x1	12	140

rtc TYPE 026 Panel Mount Hose Barb / Schottverschraubung für Schlauchanschluss

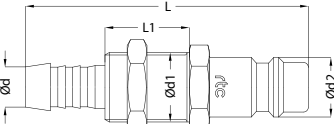
Plugs / Nippel	Size / Größe	Order No / Bestellnr.	Ød	Ød1	Ød2	L	L1	HEX.
	7.8	026 PHFP 06	6 mm	M12x1	12	57	17	14
		026 PHFP 08	8 mm	M12x1	12	57	17	14
		026 PHFP 10	10 mm	M14x1	12	57	17	17



Male thread plug with valve / Nippel mit Aussengewinde mit Ventil

TYPE 026 **rtc**

Plugs / Nippel	Size / Größe	Order No / Bestellnr. 	Ød	Ød1	L	L1	HEX.
	7.8	026 PMB 10	BSP 1/8	12	43	8	21
		026 PMB 13	BSP 1/4	12	44	9	21
		026 PMB 17	BSP 3/8	12	44	9	21
		026 PMB 21	BSP 1/2	12	45	12	22
		026 PMB 1415	M14x1.5	12	45	10	21
		026 PMB 1615	M16x1.5	12	45	10	21
		026 PMB 1815	M18x1.5	12	45	10	21



Female thread plug with valve / Nippel mit Innengewinde mit Ventil

TYPE 026 **rtc**

Plugs / Nippel	Size / Größe	Order No / Bestellnr. 	Ød	Ød1	L	HEX.
	7.8	026 PFB 10	BSP 1/8	12	42	21
		026 PFB 13	BSP 1/4	12	43	21
		026 PFB 17	BSP 3/8	12	43	21
		026 PFB 21	BSP 1/2	12	46	24
		026 PFB 1415	M14x1.5	12	45	21
		026 PFB 1615	M16x1.5	12	45	21
		026 PFB 1815	M18x1.5	12	45	22



Standard hose tail plug with valve / Nippel mit gerader Standard - Schlauchtülle mit Ventil

TYPE 026 **rtc**

Plugs / Nippel	Size / Größe	Order No / Bestellnr. 	Ød	Ød1	L	L1
	7.8	026 PHB 04	4 mm	12	57	23
		026 PHB 06	6 mm	12	57	23
		026 PHB 08	8 mm	12	57	23
		026 PHB 09	9 mm	12	57	23
		026 PHB 10	10 mm	12	57	23
		026 PHB 13	13 mm	12	57	23



Plastic hose connection plug with valve / Nippel mit gerader Kunststoffschlauch mit Ventil

TYPE 026 **rtc**

Plugs / Nippel	Size / Größe	Order No / Bestellnr. 	Ød	Ød1	Ød2	L
	7.8	026 PVB 0406	4x6 mm	M10x1	12	48
		026 PVB 0608	6x8 mm	M12x1	12	48
		026 PVB 0810	8x10 mm	M14x1	12	52
		026 PVB 0912	9x12 mm	M16x1	12	52



Plastic hose connection plug with spring guard with valve / Nippel Knickschutzfeder mit Ventil

TYPE 026 **rtc**

Plugs / Nippel	Size / Größe	Order No / Bestellnr. 	Ød	Ød1	Ød2	L
	7.8	026 PVBG 0406	4x6 mm	M10x1	12	110
		026 PVBG 0608	6x8 mm	M12x1	12	120
		026 PVBG 0810	8x10 mm	M14x1	12	130
		026 PVBG 0912	9x12 mm	M16x1	12	140



Panel mount hose barb plug with valve / Nippel Schottverschraubung für Schlauchanschluss mit Ventil

TYPE 026 **rtc**

Plugs / Nippel	Size / Größe	Order No / Bestellnr. 	Ød	Ød1	Ød2	L	L1	HEX.
	7.8	026 PHBP 06	6 mm	M10x1	12	61	10	21
		026 PHBP 08	8 mm	M12x1	12	65	14	21
		026 PHBP 10	10 mm	M14x1	12	72	14	21